



Electrical performance:  
CEI EN 50393  
as applicable

Gel: UL 94-HB

Operating temperature

Installation temperature:   
-40°C / +50°C

Fully submersible   
Can be used underground

IP68  
OFFICIALLY  
TESTED

# Little Joint

IP68, gel pre-filled micro joint, space-saver complete with connectors and with minimal aesthetic impact.

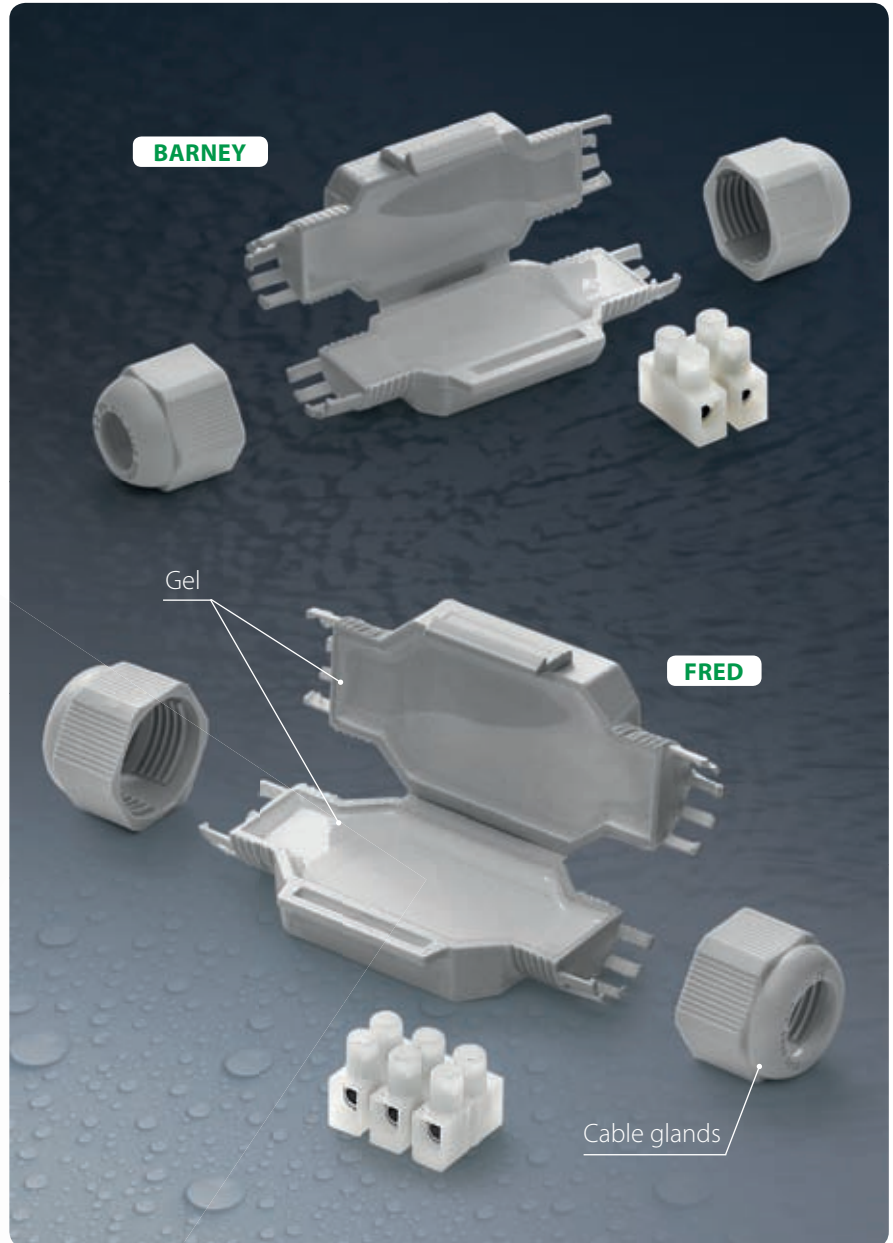



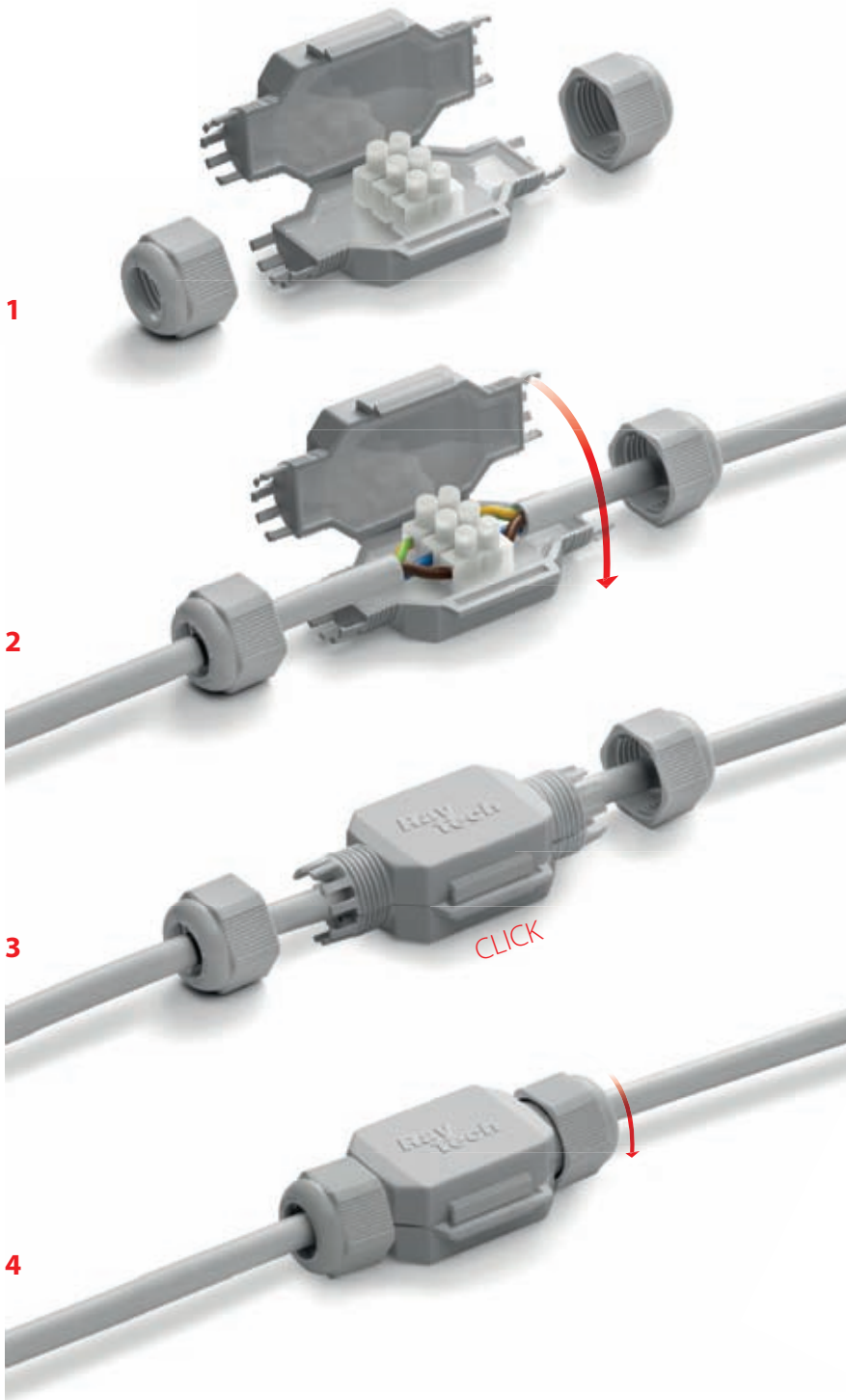

- Equipped with cable glands to avoid accidental cable traction
- Complete with screw connectors
- Pre-filled with non-toxic, non-classified gel
- Very compact and ready to use
- Always re-enterable
- Halogen free & UV resistant

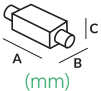

For use in traps, in lampholders for LED spotlights, especially in the presence of water and moisture, thanks to its very small size.



Product	Mammut	Cable formation max (N° x mm <sup>2</sup> )	Ø cables min - max (mm)	Pieces / Pack	 (mm)
Barney		2 x 2,5	6 - 10	1 pz / Blister	75 x 28 x 19
Barney MP		2 x 2,5	6 - 10	10 pz / Multipack	
Fred		3 x 2,5	8 - 13	1 pz / Blister	80 x 36 x 23
Fred MP		3 x 2,5	8 - 13	10 pz / Multipack	

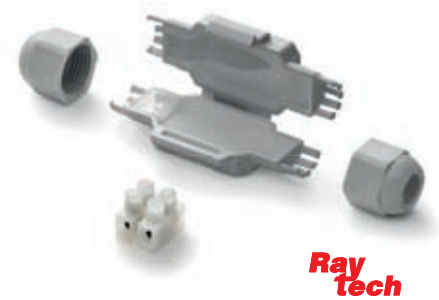

Ray  
tech